

4006-3B TEE TOWER & C21379A RECESSED DRAINER WITH 408 FAUCETS OR 525SS FAUCETS MOUNTING TEMPLATE

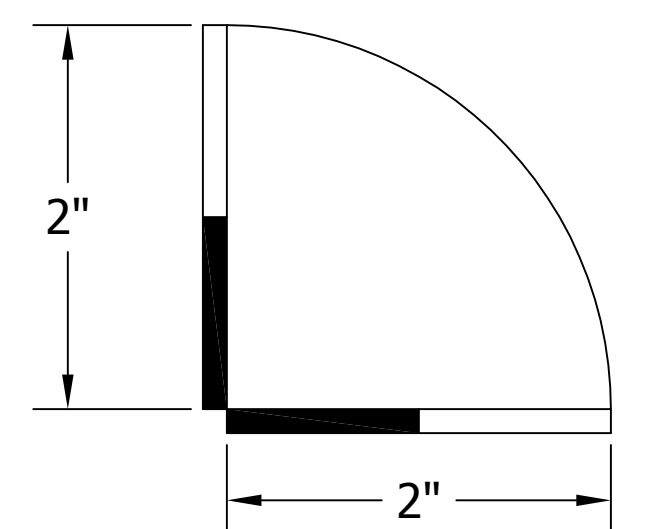
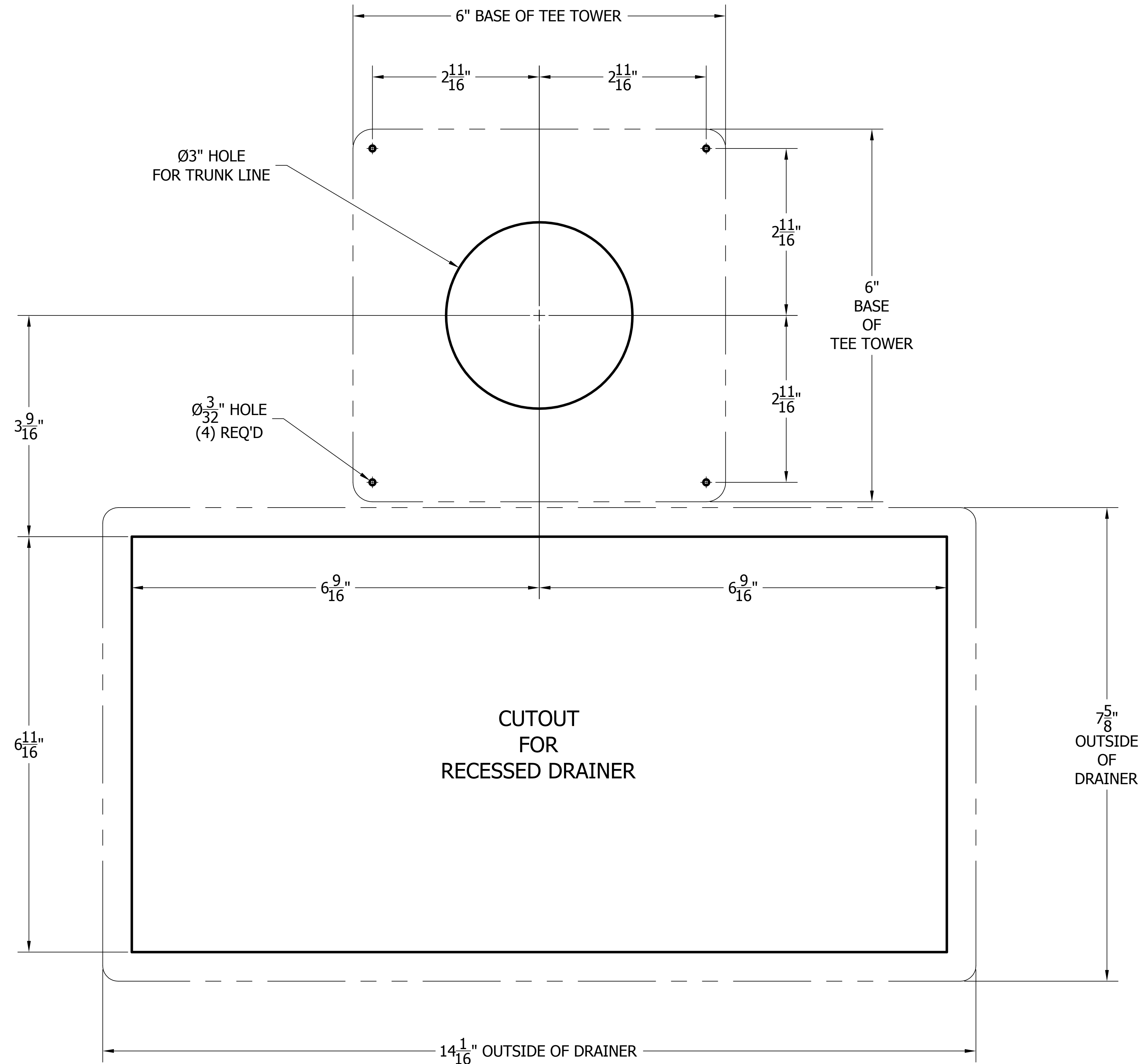
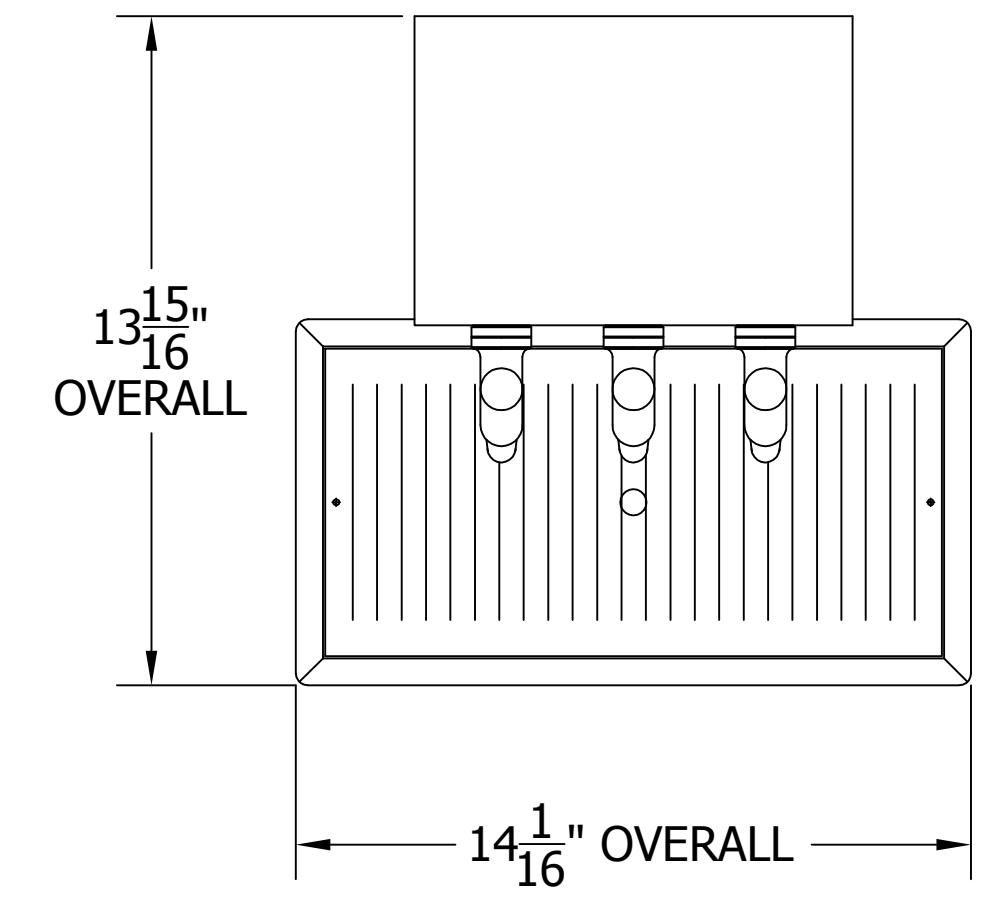
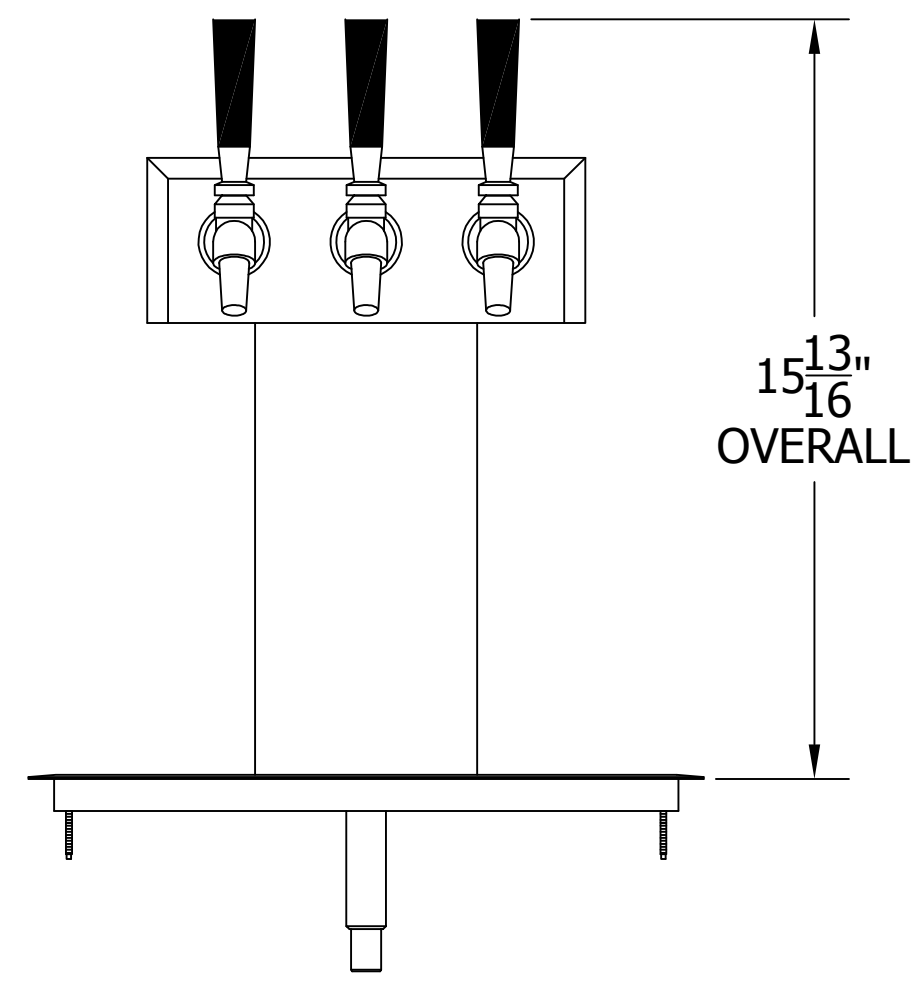

ATTENTION INSTALLERS
 VERIFY SCALE OF PRINT
 BY CHECKING THESE DIMENSIONS
 PRIOR TO INSTALLATION OF BEER HEAD
 (EACH SIDE SHOULD MEASURE
 EXACTLY 2.00 INCHES)