

# 4006S9B & C18655-GRC

## MOUNTING TEMPLATE

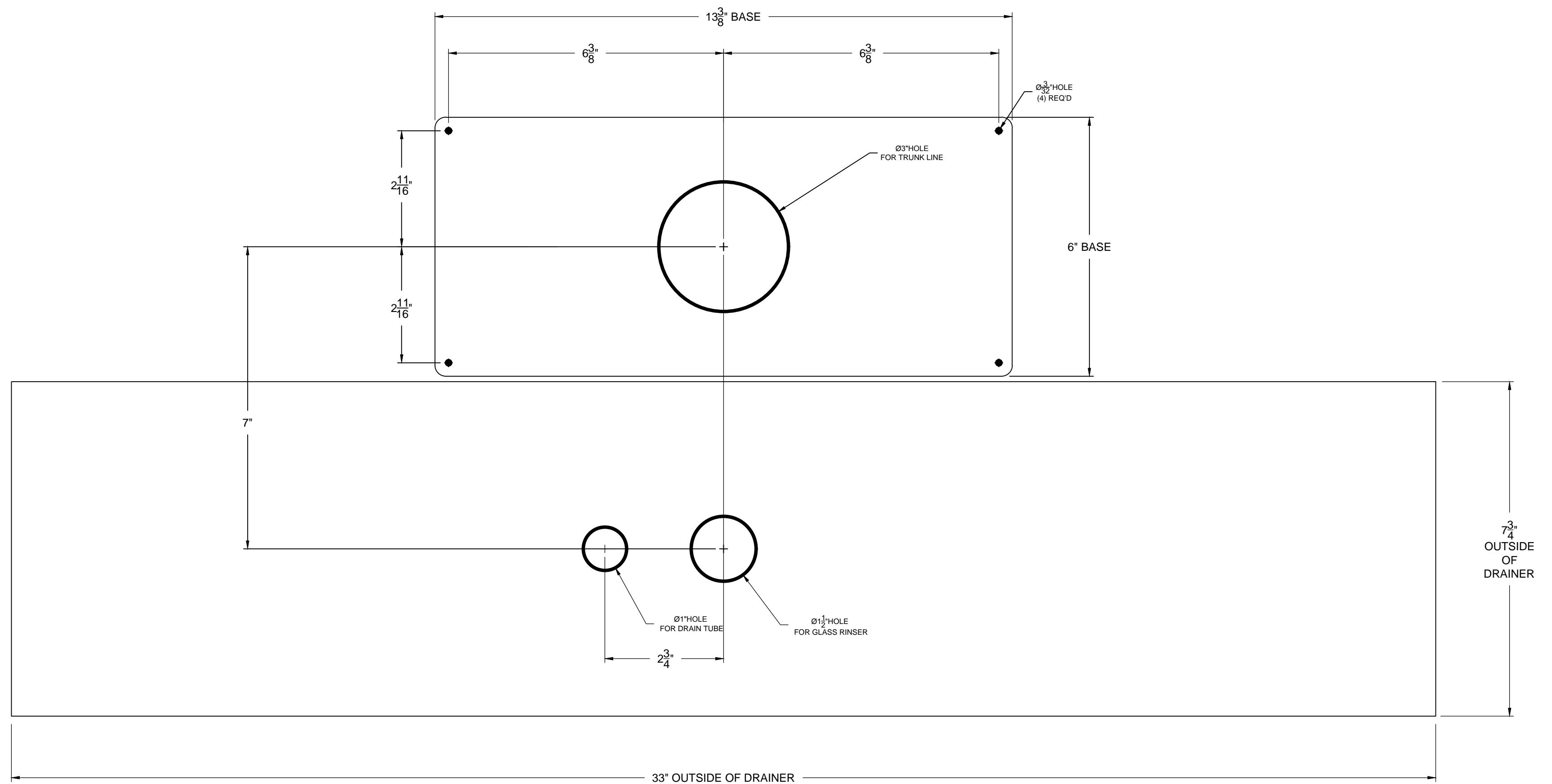
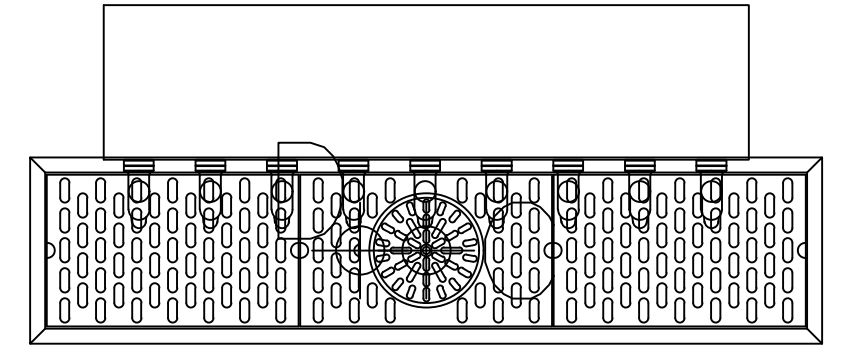
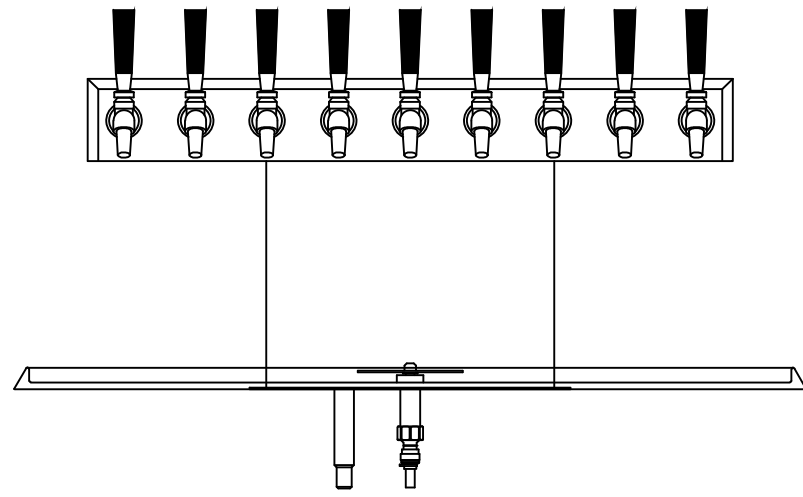

PERLICK CORPORATION  
MILWAUKEE, WI 53223  
PROPERTY OF THE PERLICK CORP.  
NOT TO BE COPIED OR USED DETRIMENTAL TO OUR INTERESTS.

SCALE 1:2  
DR. DRH DATE 8-30-2016

LAST MODIFIED  
XX-XX-XXXX

1006665