

QUICK FEATURES

- Ready to accept custom or stainless steel panel
- Two temperature zones keep red and white wine at their recommended temperatures
- Smart humidity control maintains consistent humidity levels within the cabinet automatically.
- Touch-screen control streamlines the user experience. Enjoy access to smart settings for red, white and cellar temperatures, or customize to your preference in 1° increments. Access settings for lighting, Sabbath mode and more with a single touch.
- Triple-pane, UV-resistant glass provides protection from light
- Brightly illuminated by white and blue roll-on theatre lighting
- Convertible display shelf showcases 6 prized wine bottles with additional storage for 4 dessert (half sizes) wine bottles when angled up. Easily lays flat to store 11 bottles without additional parts and pieces.

PRODUCT SPECIFICATIONS

Appliance Dimensions	Exterior Width	23-3/4"
	Exterior Depth	24"*
	Exterior Height	83-11/16"
Required Cutout Dimensions	Cutout Width	24"
	Cutout Depth	25"
	Cutout Height	84"
Depth with Door Open	49-3/4" (less door overlay installed)	
Product Weight	541 lbs	
Capacity	12.2 cu. ft.	
Electrical Requirements	Electrical Supply	115V, 60 Hz., 1 Phase, 2.3 amps
	Electrical Service	15 amp dedicated circuit
	Power Cord/ Receptacle	NEMA 5-15 plug, 5' /3 prong grounding-type
Max Bottle Capacity	Dual-Zone	86 (750 ml.)

*Less panel. With typical 3/4" overlay panel installed, depth becomes 24-3/4"

TEMPERATURE RANGES

Red Wine Zone (Top)	Factory Set to 60° (Range 40°-68°F)
White Wine Zone (Bottom)	Factory Set to 50° (Range 40°-68°F)
Cellar Mode (All)	Factory Set to 55° (Range 40°-68°F)

NOTE: Dual Zone Wine Upper compartment temperature setpoint must always be set at or above the lower compartment setpoint.

ACCESSORIES

36" Two Tone Polished Chrome and Stainless Steel handle
Field Installed Stainless Steel overlay for glass door (Left or Right hinged) w/ lock
Stainless Steel Finish Panel for Left or Right Side

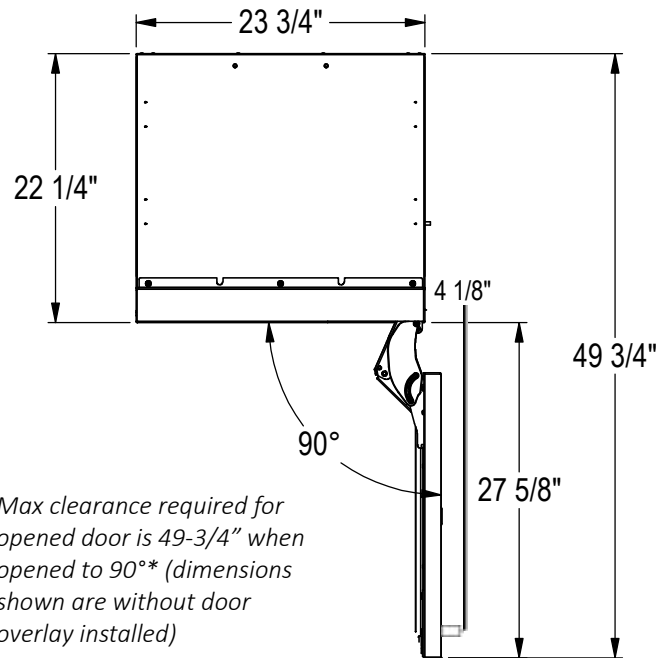

Max clearance required for opened door is 49-3/4" when opened to 90°* (dimensions shown are without door overlay installed)

(please note that door opens to 115°)

*90° achieved when included hinge stop pin is installed. Pin must be installed prior to full integration

AVAILABLE MODELS

CR24D-1-4L	Dual-zone wine, glass overlay ready, hinged left
CR24D-1-4R	Dual-zone wine, glass overlay ready, hinged right

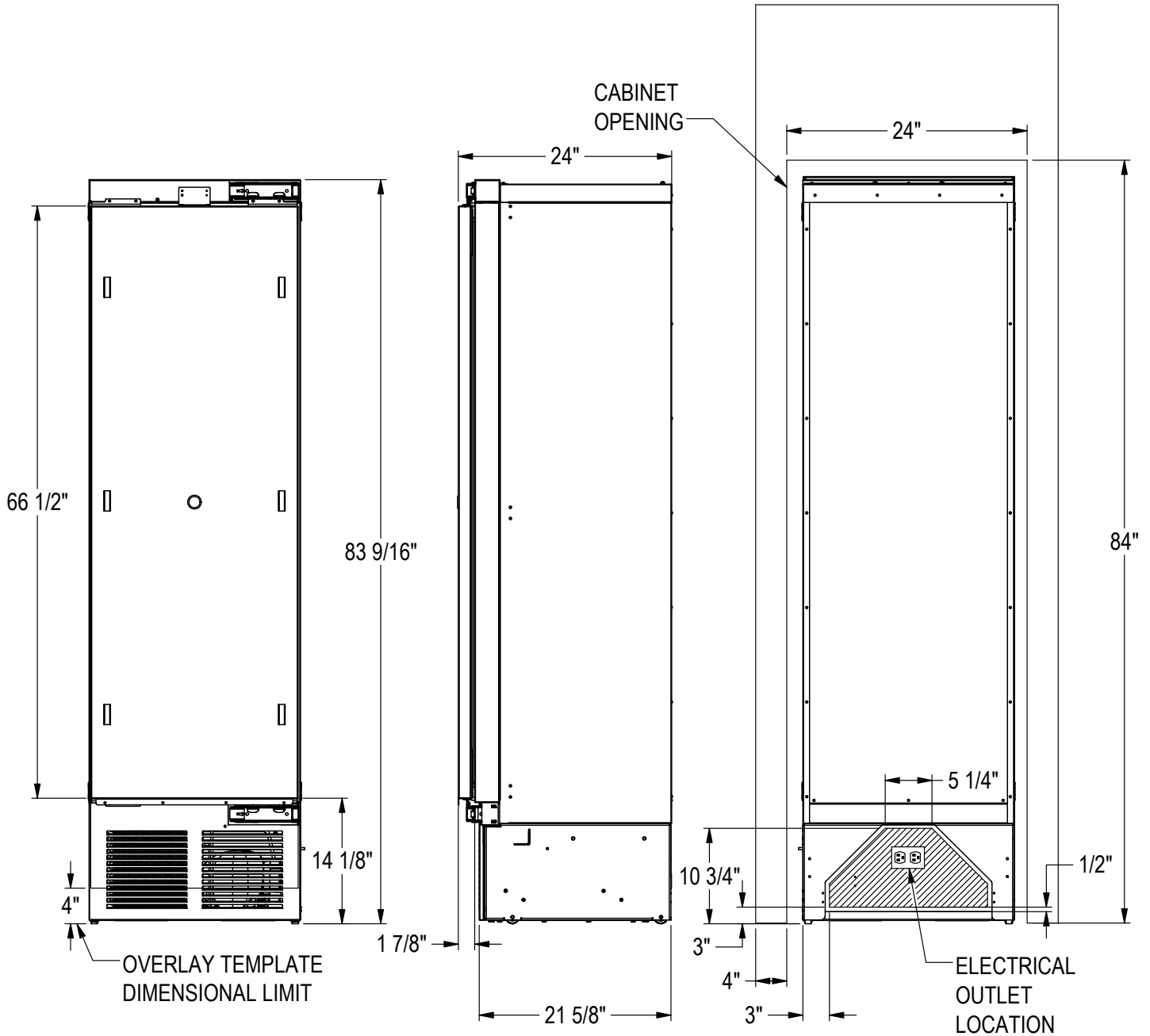

ACCESSORIES

- Dual installation kits
- Stainless steel exterior side finishing panels
- Stainless steel door panels with Perlick Pro Handle

Perlick accessories are available for purchase through an authorized Perlick dealer. For a full list of accessories and to find a dealer near you, visit perlick.com/residential.